

Series: COMPACT-FAN Type D/DS

double inlet
with forward curved blades

FISCHBACH

Luft- und Ventilatorentechnik GmbH

EC-MOTOR
EC-MOTEUR

Type: D670/DM500

ERP KONFORM

CE -conform

UK
CA



manufacturer:

Fischbach Luft- und Ventilatorentechnik GmbH

Am Hellerberg 22-24

D-57290 Neunkirchen

phone:

++49(0)2735/777-0

telefax:

++49(0)2735/770-133

internet:

www.fischbach-luft.de

email:

info@fischbach-luft.de

Technical Data

weight:	(kg)	25
material housing:	steel, galvanized	
material impeller:	steel, galvanized	
direction of rotation:	left	
motor protection class:	IP 65	
insulation class:	F	
motor protection:	thermal contact	

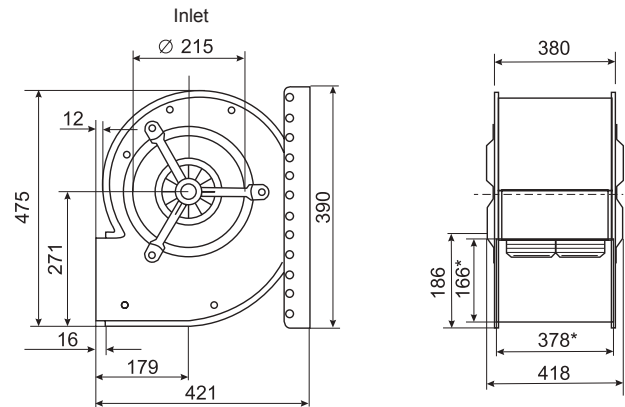

*external dimension of discharge

**connection plan*
FFU-EC 400**

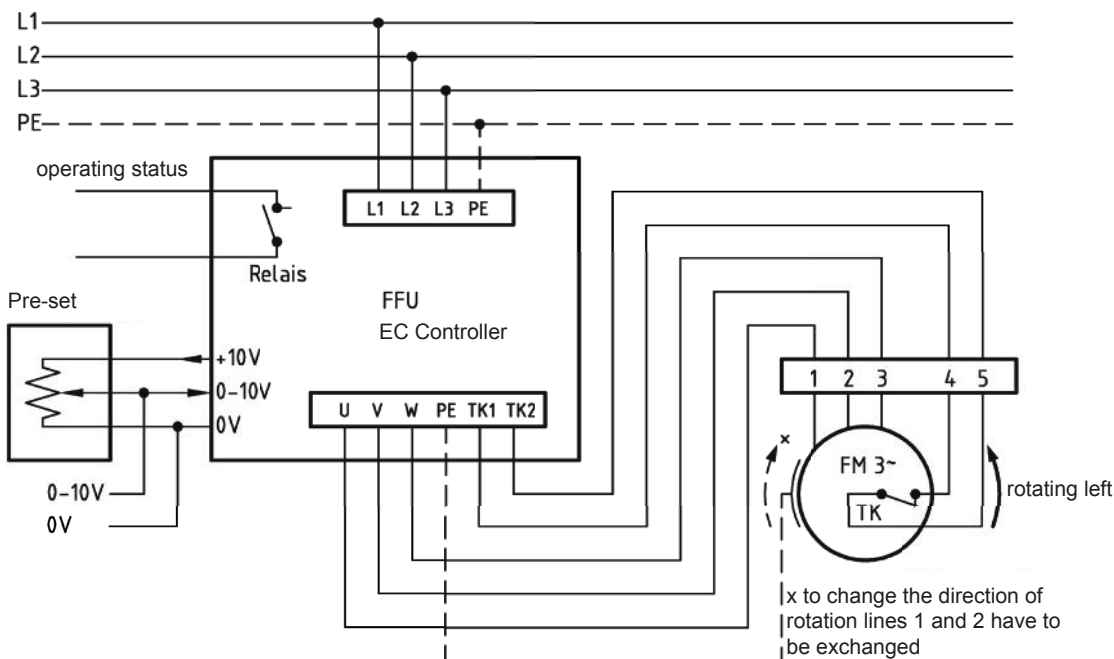

* Connection only according to the enclosed technical documentation.

the silent one



Series: COMPACT-FAN Type D/DS

double inlet
with forward curved blades

FISCHBACH

Luft- und Ventilatorentechnik GmbH

EC-MOTOR
EC-MOTEUR

Type: D670/DM500

Erp 2013 2015 2018 x

Performance data

main voltage:	(V)	400 (3~)
frequency:	(Hz)	50
current max.:	(A)	2,7
power input max.:	(kW)	1,3
air flow volume max.:	(m³/h)	5488
statical pressure max.:	(Pa)	462
speed max.:	(rpm)	1350
supply air temperature:	(°C)	-20... +50
capacitor:	(µF)	-

ErP-Data:

total efficiency fan (η_e):	(%)	48,2
installation category:		A
efficiency category:		static
efficiency grade: N	(%)	42
target efficiency (η_{target}):	(%)	38,3
speed controller		yes
year of manufacturing		since 2015
manufacturer:	Fischbach Luft- und Ventilatorentechnik GmbH D-57290 Neunkirchen / HRB 5804 Siegen	
order no.		18116230
power input:	(kW)	0,55
air flow volume:	(m³/h)	2224
statical pressure:	(Pa)	388
speed:	(rpm)	1350
specific ratio:		1

disassembling/recycling/disposal: see page decommission
installation/operation/maintenance: see operating and mounting instructions
measurement for determination of efficiency without additional items

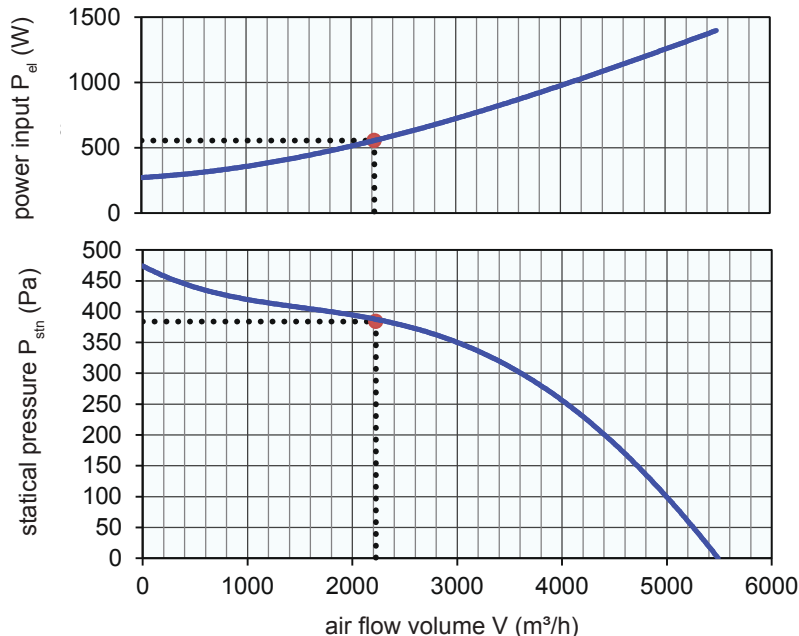

EC-controller included / accessories / sound data, please see in the appropriate table

Technical documentation according to page: **General information**