

**Series: FREEWHEELING IMPELLER with  
INSTALLATION FRAME FLRE**  
with backward curved blades

**FISCHBACH**

Luft- und Ventilatorentechnik GmbH

**Type: FLRE355/E15**

**ERP KONFORM**



**CE** -conform

**manufacturer:**

Fischbach Luft- und Ventilatorentechnik GmbH  
Am Hellerberg 22-24  
D-57290 Neunkirchen  
phone: ++49(0)2735/777-0  
telefax: ++49(0)2735/770-625  
internet: www.fischbach-luft.de  
email: info@fischbach-luft.de

**Technical Data**

weight:	(kg)	18
material housing:	steel, galvanized	
material impeller:	steel, galvanized	
direction of rotation:	left/right	
motor protection class:	IP 65	
insulation class:	F	
motor protection:	thermal contact	

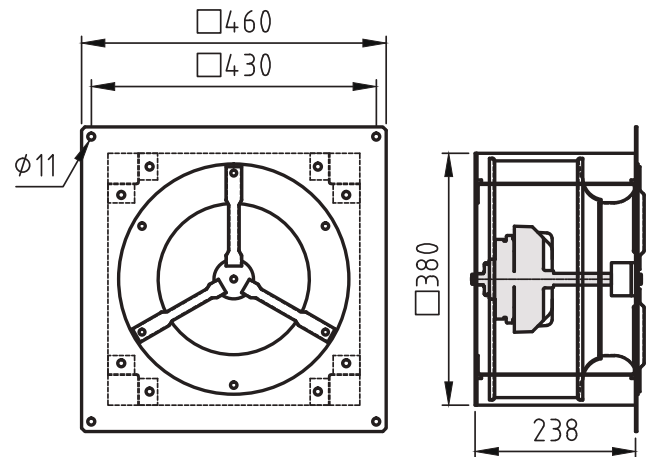

connection plan  
0.11-1 r.

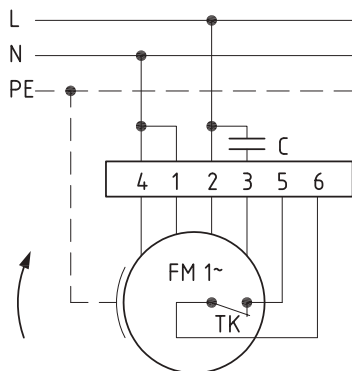

rotating right

connection plan  
0.11-1 l.

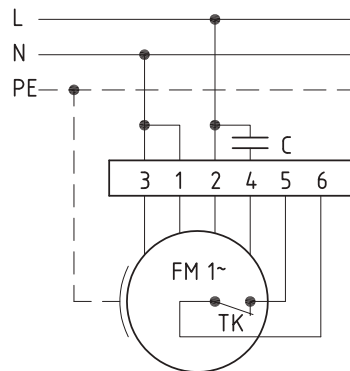

rotating left



the silent one

**Series: FREEWHEELING IMPELLER with  
INSTALLATION FRAME FLRE**

with backward curved blades

**FISCHBACH**

Luft- und Ventilatorentechnik GmbH

**Type: FLRE355/E15**

Erp 2013 2015 x 2018

**Performance data**

main voltage:	(V)	230 (1~)
frequency:	(Hz)	50
current max.:	(A)	1,5
power input max.:	(kW)	3,0
air flow volume max.:	(m³/h)	3043
statical pressure max.:	(Pa)	375
speed max.:	(rpm)	1393
supply air temperature:	(°C)	-25...+70
capacitor:	(µF)	10

**ErP-Data:**

total efficiency fan ( $\eta_e$ ):	(%)	46,0
installation category:		A
efficiency category:		static
efficiency grade: N	(%)	62
target efficiency ( $\eta_{target}$ ):	(%)	45,8
speed controller		no
year of manufacturing		since 2015
manufacturer:	Fischbach Luft- und Ventilatorentechnik GmbH D-57290 Neunkirchen / HRB 5804 Siegen	
order no. (left)		18027010
power input:	(kW)	0,285
air flow volume:	(m³/h)	1780
statical pressure:	(Pa)	265
speed:	(rpm)	1314
specific ratio:		1

disassembling/recycling/disposal: see page decommission  
installation/operation/maintenance: see operating and mounting instructions  
measurement for determination of efficiency without additional items

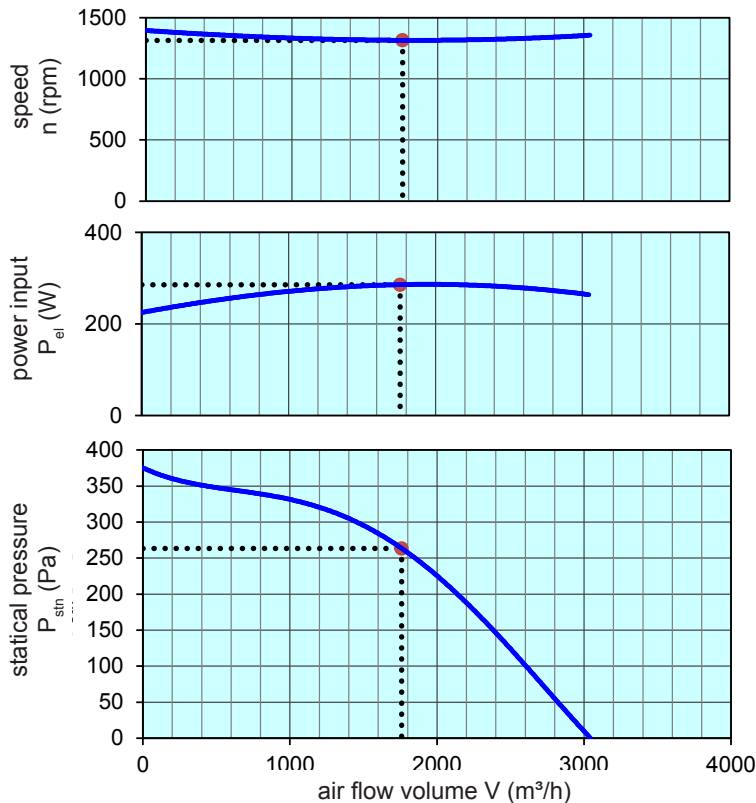

Voltage Control	type	order-no.
FISCHBACH-Speed-Controller, stepless	FDR 32	6162
FISCHBACH-Speed-Controller, stepwise	FDR 420	6201
FISCHBACH-Automatic-Control	FRA 32	6251
FISCHBACH-Control-Unit	FRE 6	63001

Technical documentation according to page: **General information**